

ITEM NUMBER	CIRCUIT SIZE
428B-0212	2
428B-0312	3
428B-0412	4
428B-0512	5
428B-0612	6

LEGEND
 428B - ** + 2
 CIRCUIT SIZE
 02-06
 MOUNTING EAR OPTION
 1 = WITH MOUNT. EARS
 2 = W/O MOUNT. EARS
 T.P.A. OPTION
 2 = WITH T.P.A.

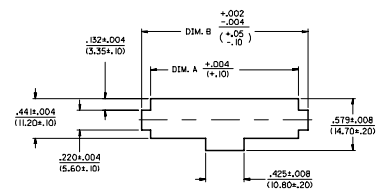

RECOMMENDED PANEL CUT-OUT DETAIL
 (PANEL THICKNESS .071(1.80) MAX.)

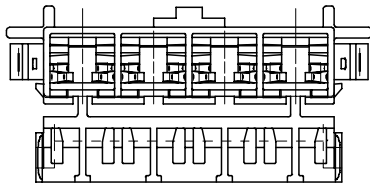
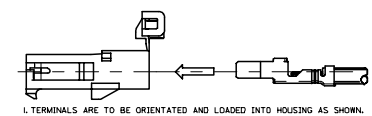

1. TERMINALS ARE TO BE ORIENTATED AND LOADED INTO HOUSING AS SHOWN.

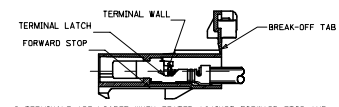
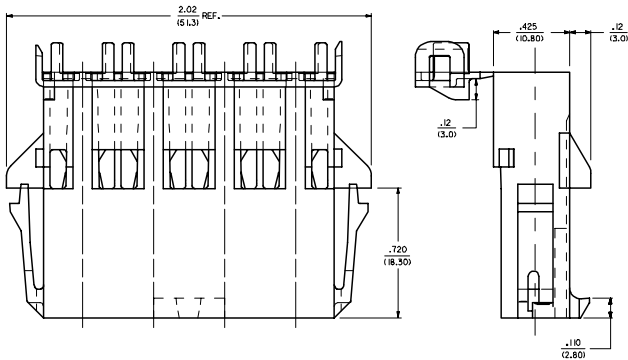

2. TERMINALS ARE LOADED WHEN SEATED AGAINST FORWARD STOP AND TERMINAL LATCHES ARE SNAPPED BEHIND TERMINAL WALLS. RETENTION FORCE AT THIS STAGE ± 0.5 Kg.

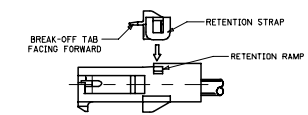

3. AFTER TERMINALS ARE LOADED INTO HOUSING, T.P.A. IS TO BE "BROKEN OFF", ORIENTATED AND INSTALLED IN THE DIRECTION SHOWN UNTIL THE RETENTION STRAPS SNAP OVER THE RETENTION RAMPS. THIS PRODUCT MUST NEVER BE USED WITHOUT THE INSTALLATION OF THE T.P.A.

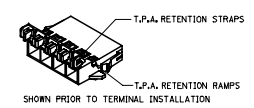
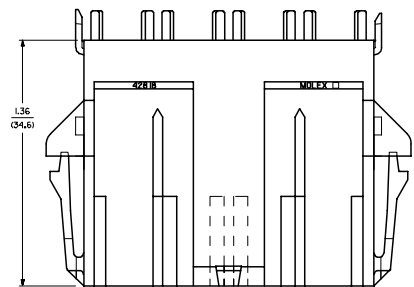

SHOWN PRIOR TO TERMINAL INSTALLATION

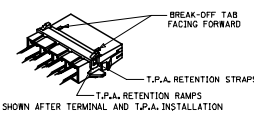

SHOWN AFTER TERMINAL AND T.P.A. INSTALLATION

- NOTES:**
- MATERIALS
 1 = POLYESTER, PBT, UL, 94V-0
 COLOR: MOLDED BLACK
 - PART IS FOR USE WITH MALE CRIMP TERMINAL *428IT.
 - PART IS DESIGNED IN METRIC.
 - NO CORE-OUT UNDER RAMP ON 3 AND 5 CIRCUIT PARTS.
 - PART MATES WITH MINI-FIT SR. RECEPTACLE 428B-***12.
 - ITEM NUMBERS THAT ARE PRECEDED BY AN "X" IN THE CHART ARE NOT AVAILABLE.
 - DUE TO THE BREAKAWAY DESIGN OF THE T.P.A. COVER A FEW MAY HAVE PREMATURELY SEPARATED FROM THEIR HOUSINGS DURING SHIPMENT, IF A HOUSING IS MISSING A T.P.A. COVER, IT CAN BE FOUND IN THE SHIPPING CONTAINER.
 - EACH WIRE MUST BE DRESSED SUCH THAT THE TERMINAL MAINTAINS ITS FREE FLOAT WITHIN THE HOUSING. SEE CHART FOR RECOMMENDED CABLE TIE PLACEMENT.
 - FOR PACKAGING INFORMATION SEE PK-428B-001

*** THIS PRODUCT MUST NEVER BE USED WITHOUT THE T.P.A. ***

DIM. C	DIM. A	DIM. B	CIRCUIT SIZE
12.7	.854(21.70)	L083(27.50)	2
19.1	L248(31.70)	L476(37.50)	3
25.4	L642(41.70)	L870(47.50)	4
31.7	2.036(51.70)	2.264(57.50)	5
38.1	2.429(61.70)	2.657(67.50)	6

DRAWN BY: [Signature] CHECKED BY: [Signature] APPROVED BY: [Signature]	QUALITY SYMBOLS 	GENERAL TOLERANCES (UNLESS SPECIFIED) DIM. PLACES ±.010 3 PLACES ±.025 2 PLACES ±.024 1 PLACE ±.060 ANGULAR ±1/2°	DIMENSION STYLE IN/MM	SCALE 1:1	DESIGN UNITS METRIC	THRD ANGLE PROJECTION 	
	DRAWN BY: JEP DATE: 11/3/96	CHECKED BY: [Signature] DATE: 11/3/96	APPROVED BY: [Signature] DATE: 11/3/96	MATERIAL NO. SD-42818-***2	DOCUMENT NO. SD-42818-***2	TITLE PLUG HOUSING, BUILT-IN TPA, 10MM CENTERS MINIFIT SR. SERIES	SHEET NO. 1 OF 1
	DRAFT WHERE APPLICABLE MUST REMAIN WITHIN DIMENSIONS						
	THIS DRAWING CONTAINS INFORMATION THAT IS PROPRIETARY TO MOLEX INCORPORATED AND SHOULD NOT BE USED WITHOUT WRITTEN PERMISSION						